

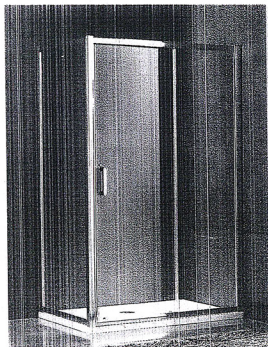

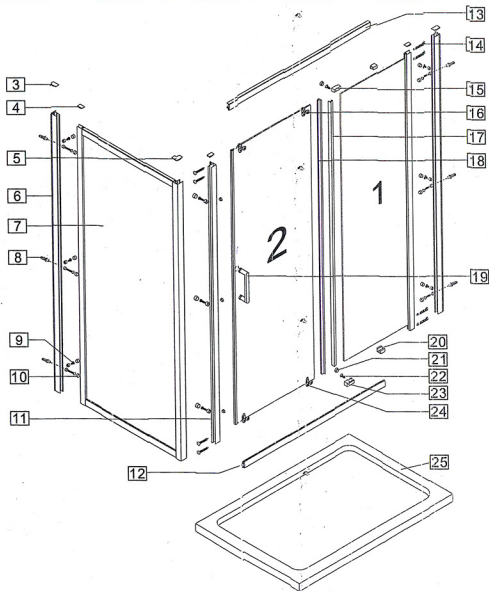











- Ⓟ Instrukcja montażu
- Ⓔ Assembly instruction
- Ⓜ Montageanleitung
- Ⓛ Montavimo instrukcija
- Ⓡ Инструкция по монтажу
- Ⓤ Інструкція монтажу











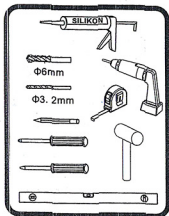



S301 91A/B/C+A-70/75/80/85/90/100



Nr No. Nr №	Mark Bezeichnung Oznaczenie Обозначение	Number of Items SZTUK шт
1		1
2		1
3	 L  R	2
4		3
5		1
6		2
7		1
8	 $\Phi 8$	6+2
9	 $\Phi 10$	9+2
10		15+4
11		1
12		1
13		1

2



Nr No. Nr №	Mark Bezeichnung Oznaczenie Обозначение	Number of Items SZTUK шт
14	 ST4×30	14+4
15	 L	1
16		2
17	 L1 L1<L2	1
18	 L2 L1<L2	1
19		1
20		2
21		5+2
22	 ST4×10	2+2
23	 R	1
24		2
25		1

3

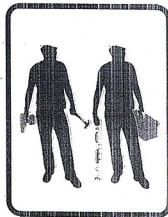

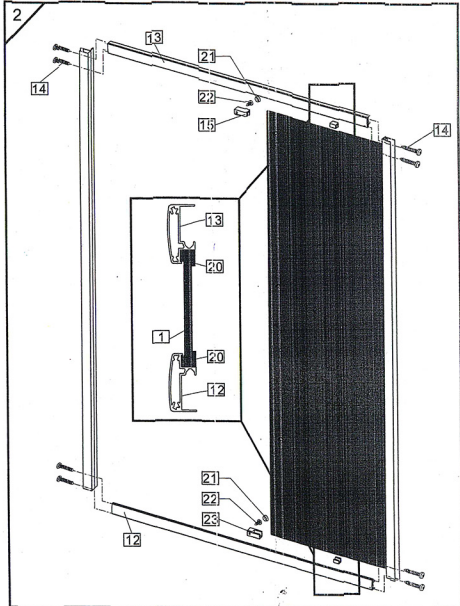
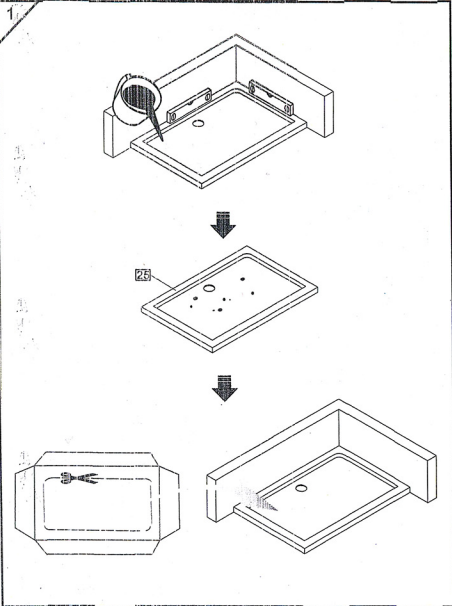

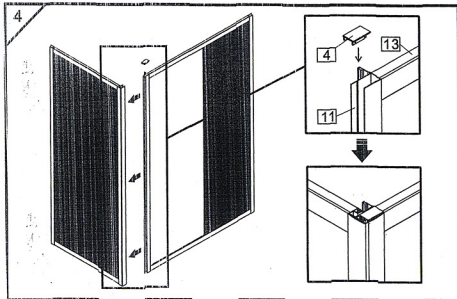
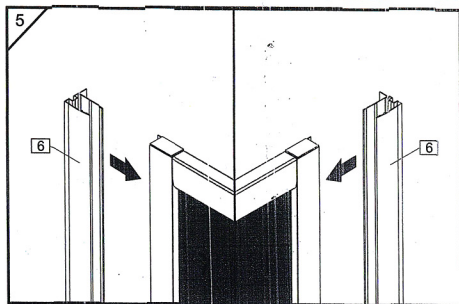
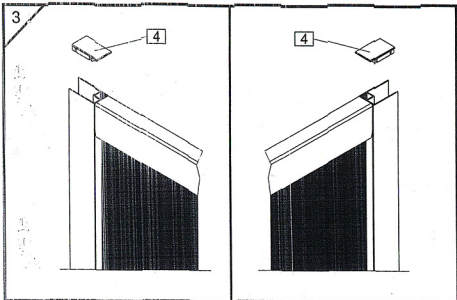

⑥

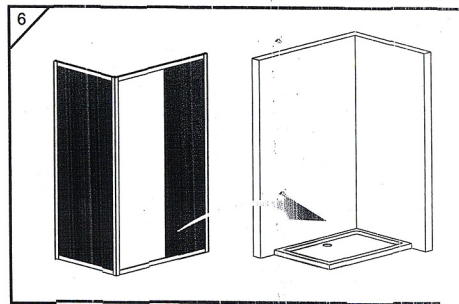

⑦

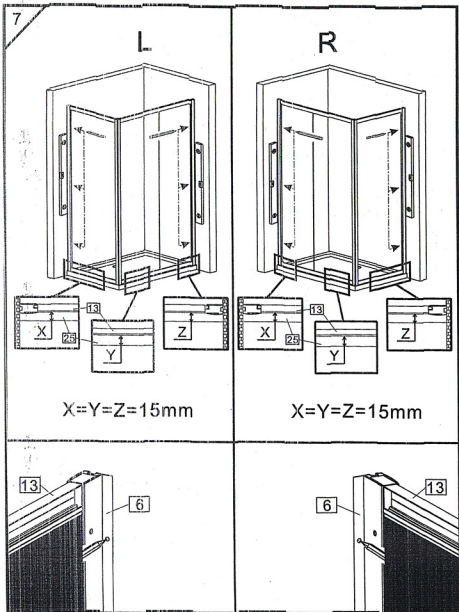

8

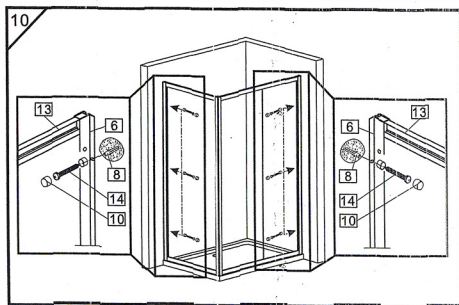
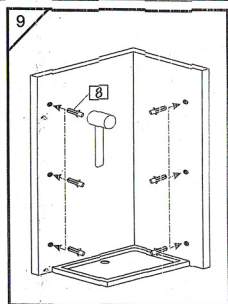
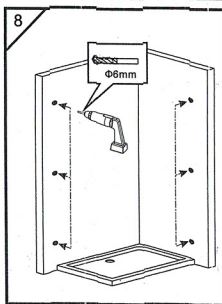

9

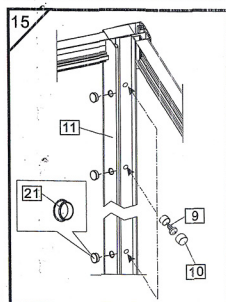
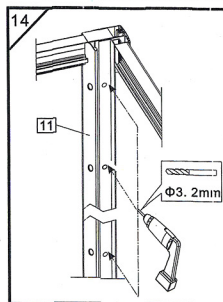
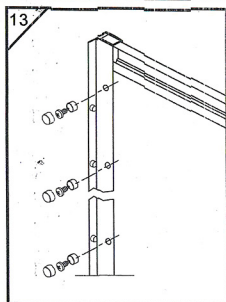
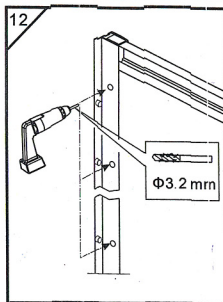
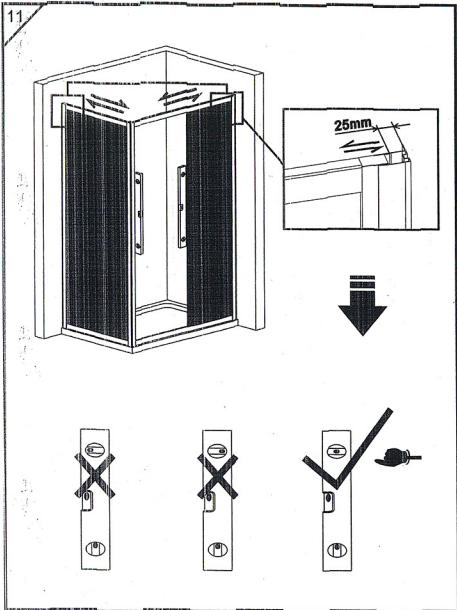

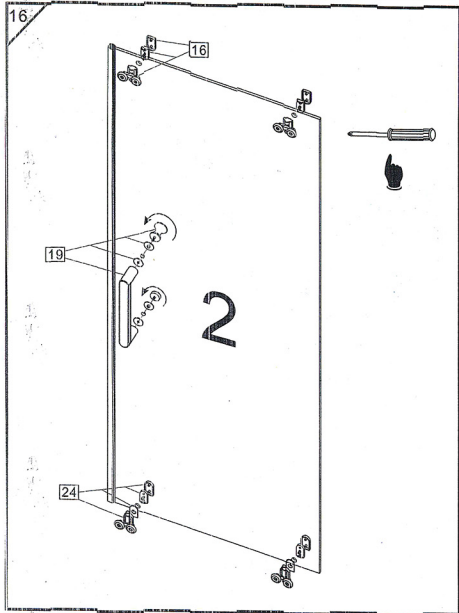

12

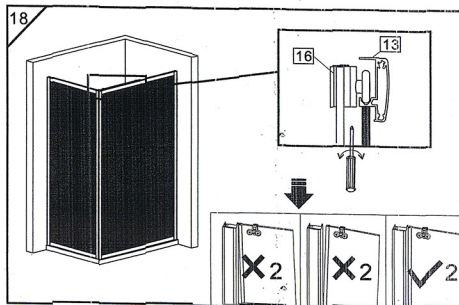
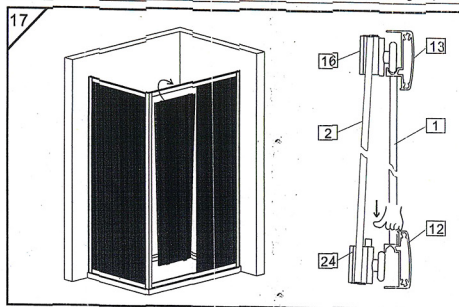

13

19

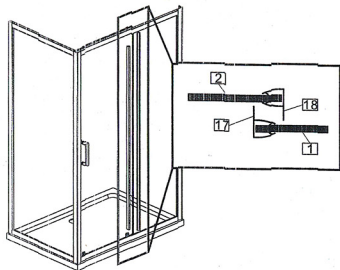

20

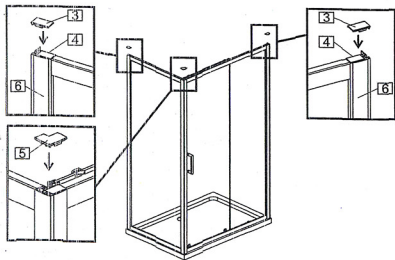

14

21



24h

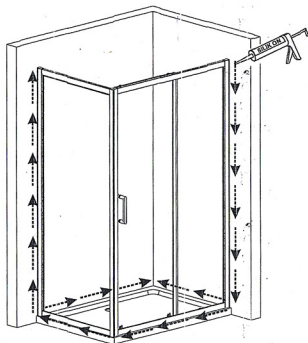

15